

Shanon 34 4X6

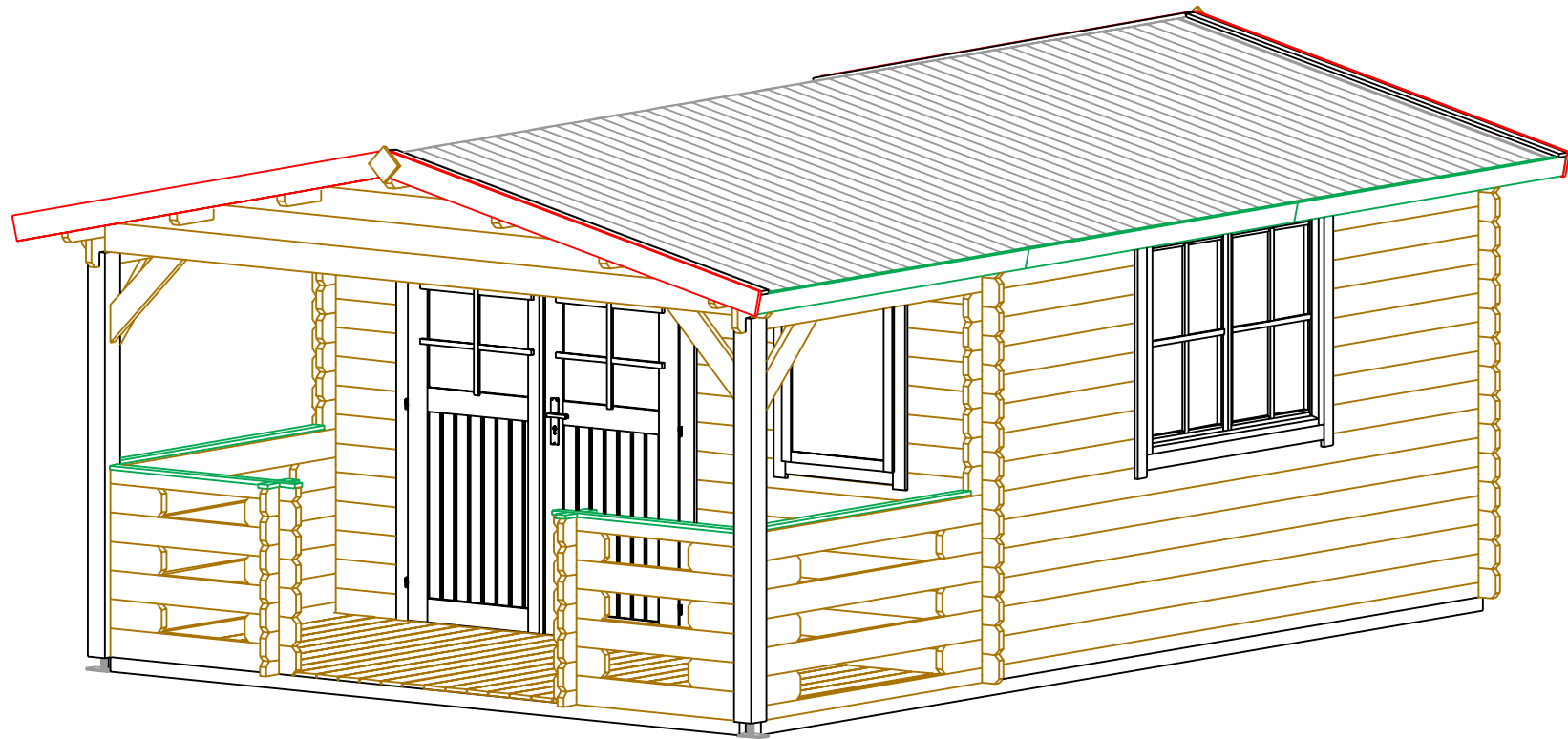

Shanon 34 4X6

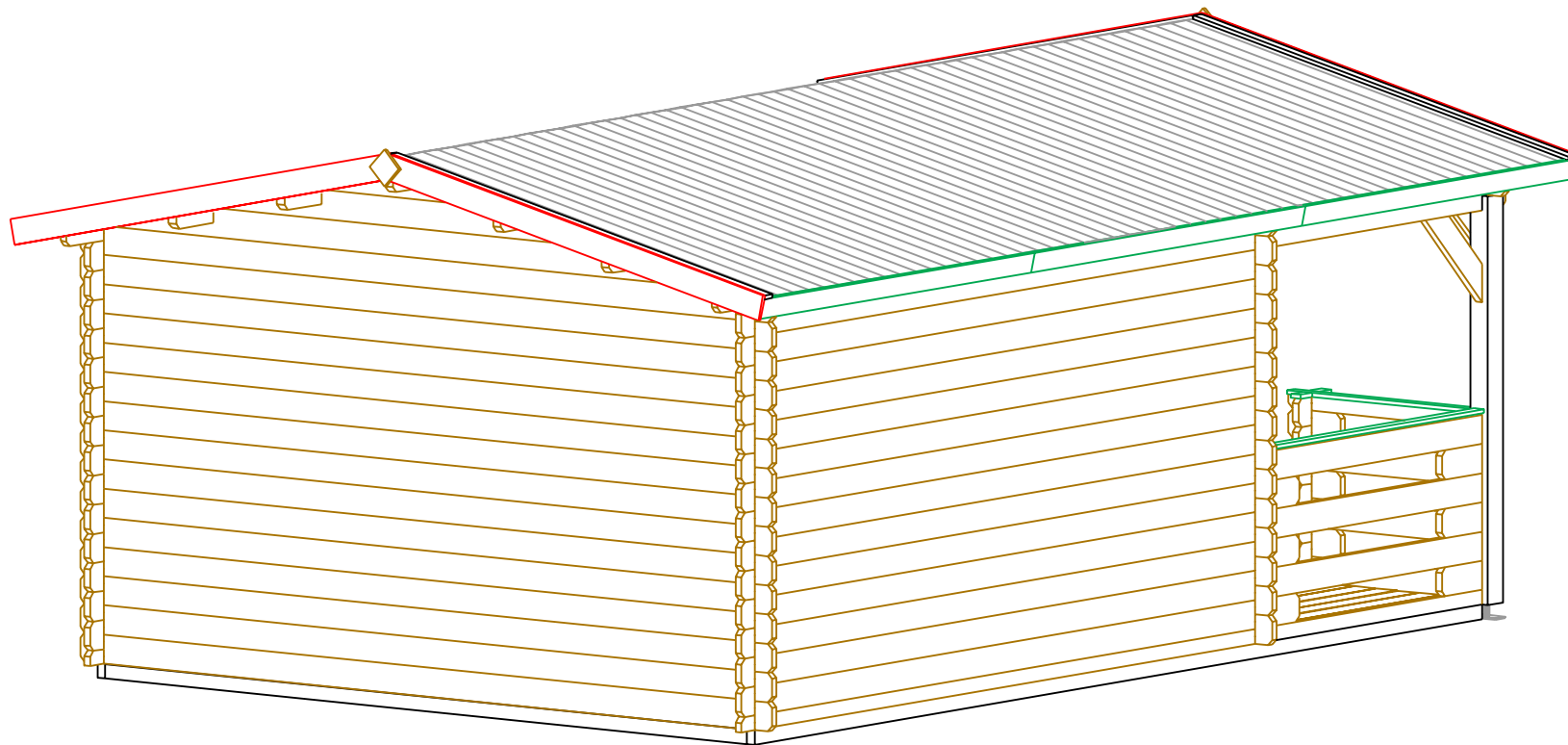

STAGE 1

Shanon 34 4X6

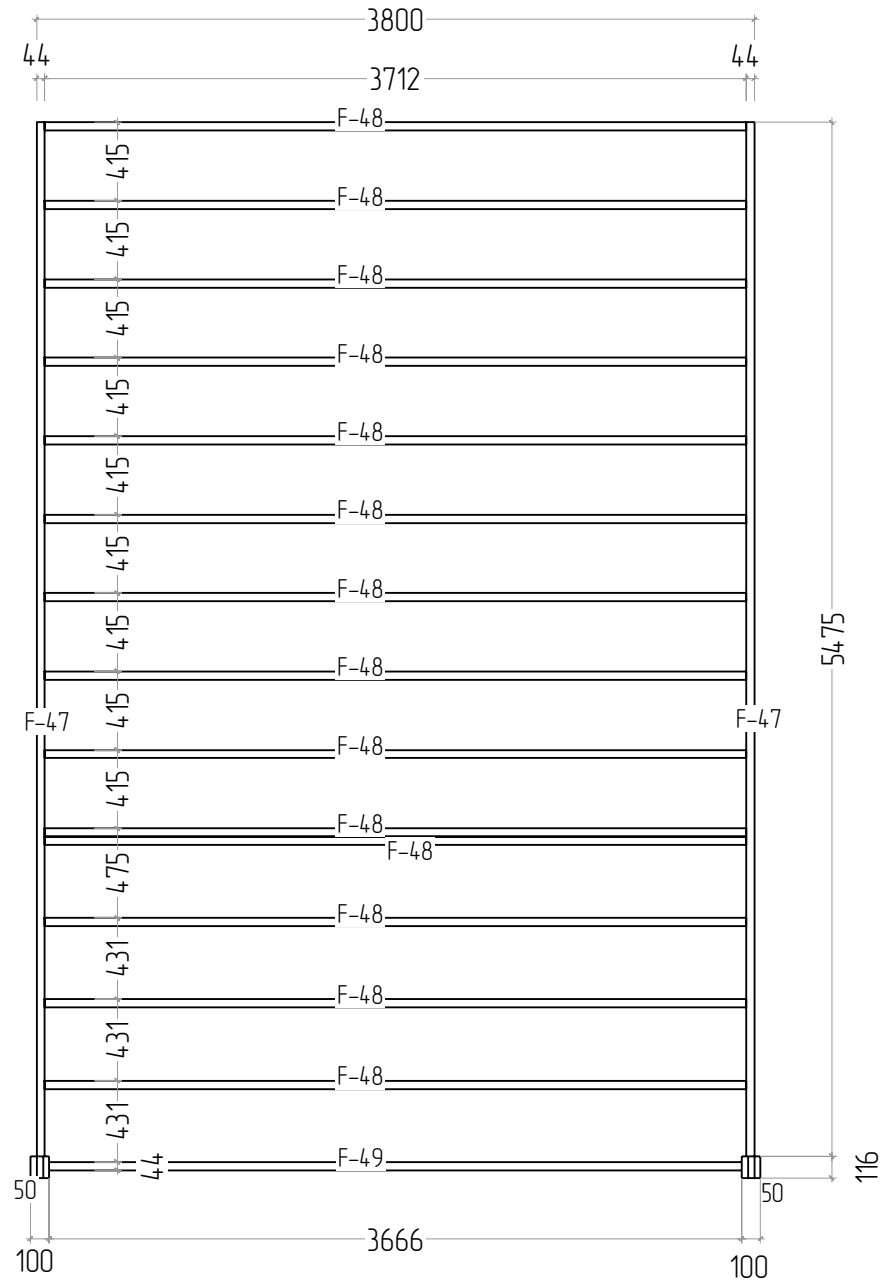

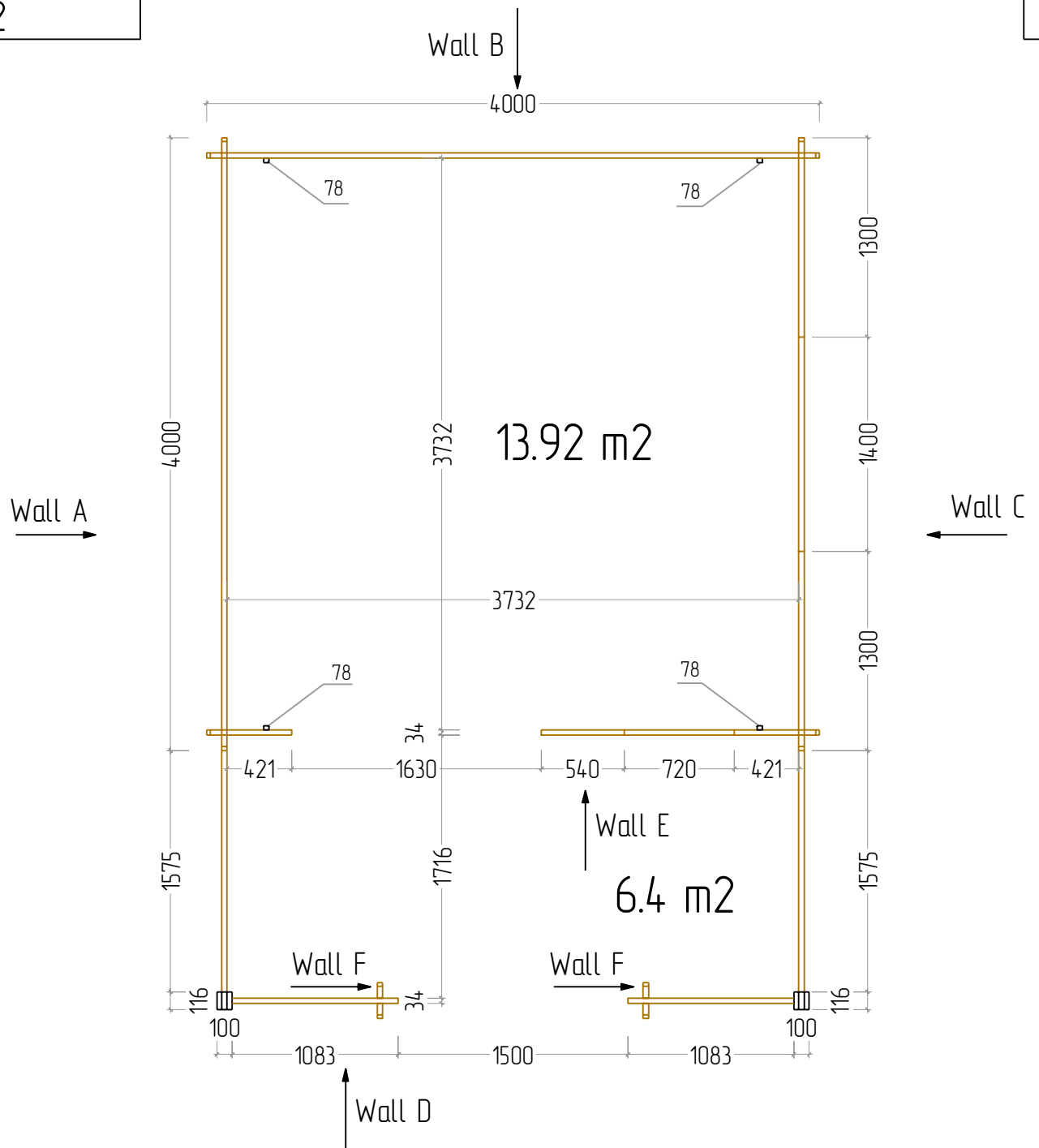

W-A

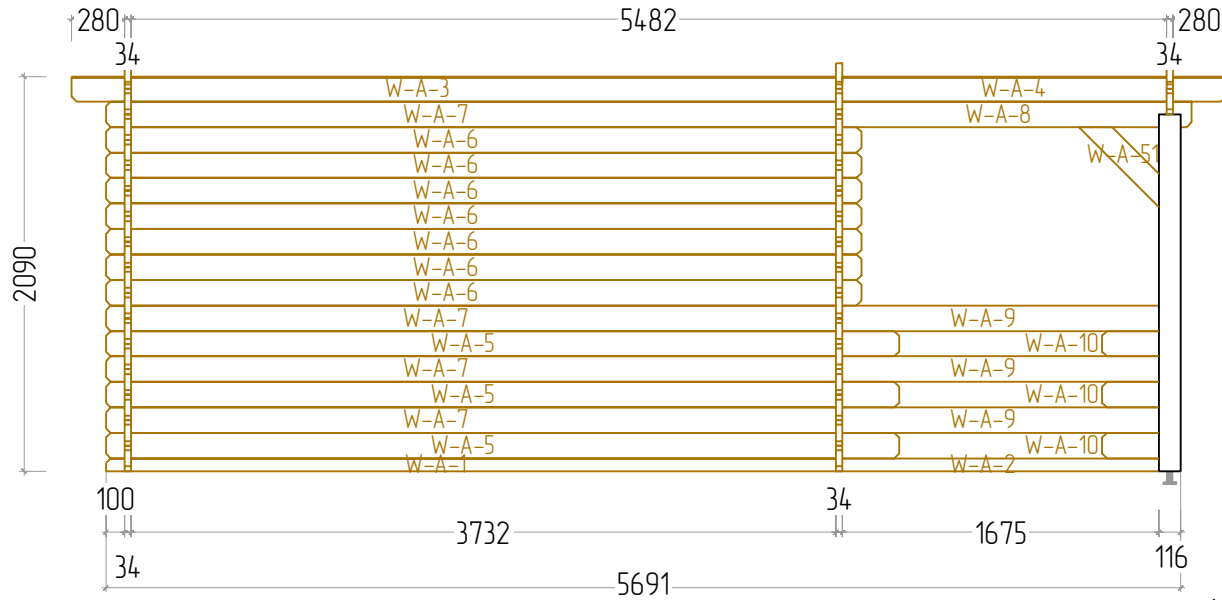

W-B

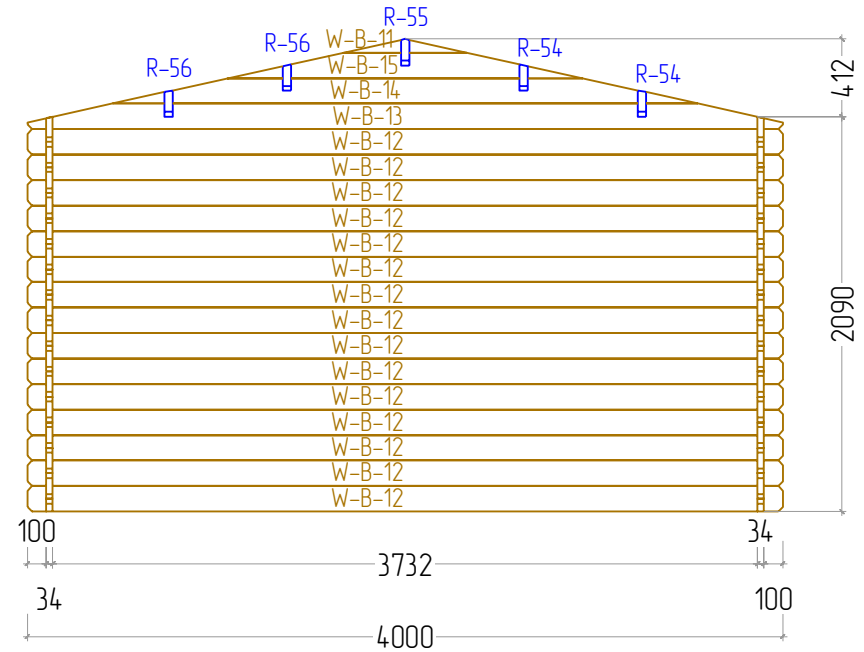

W-C

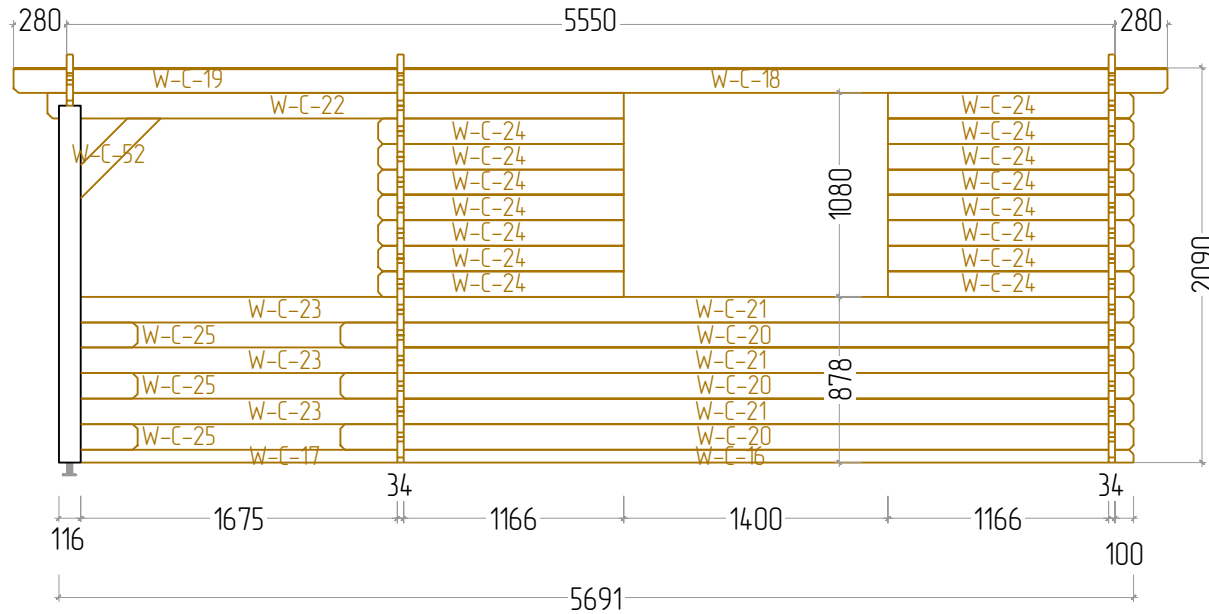

W-D

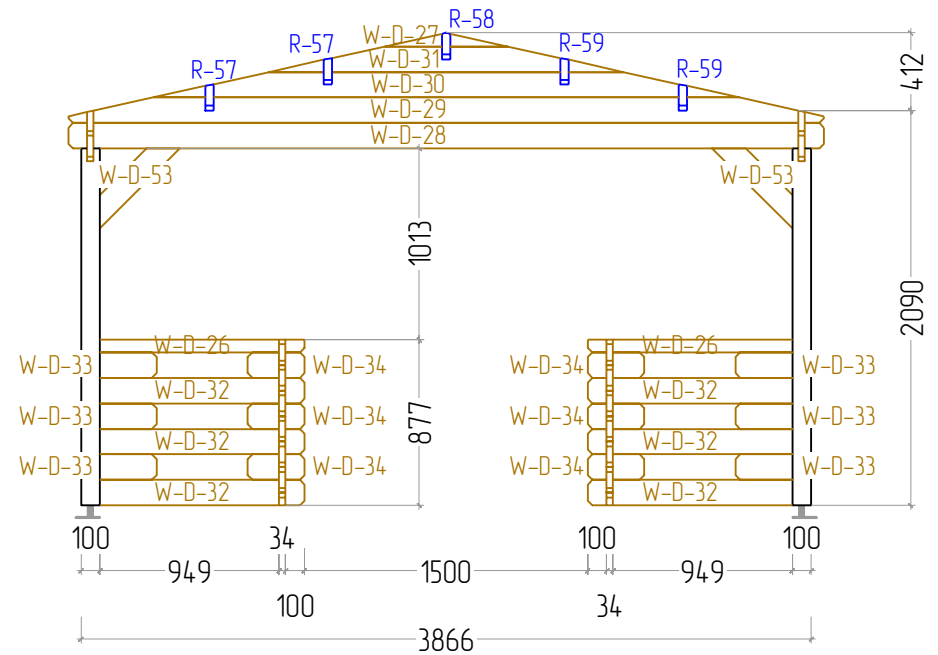

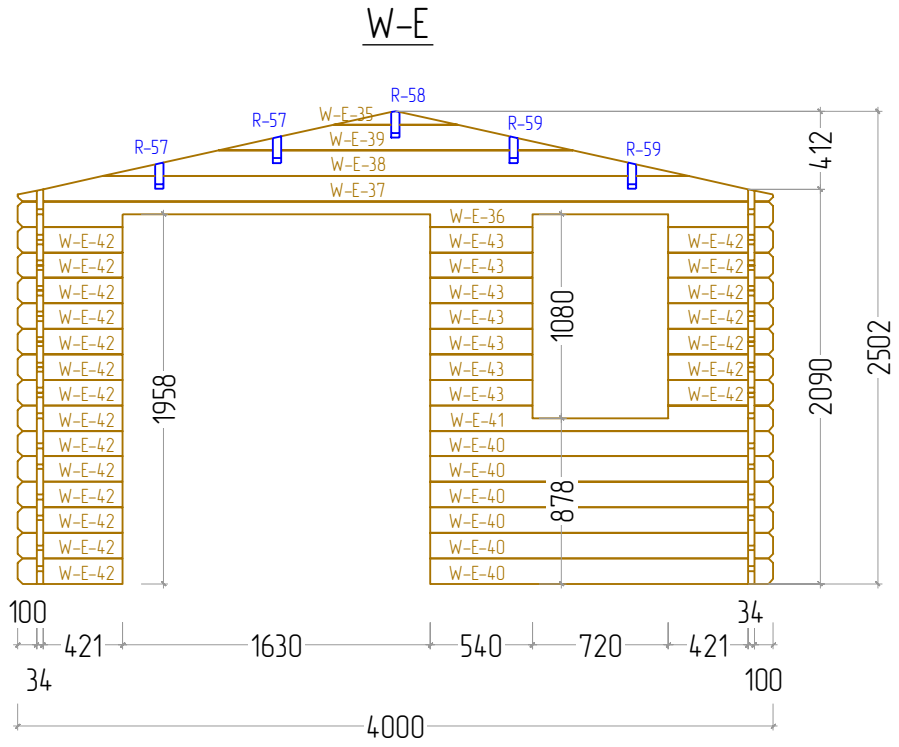

W-F (2 pcs)

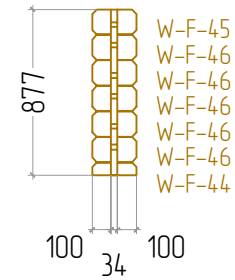

STAGE 2

Shanon 34 4X6

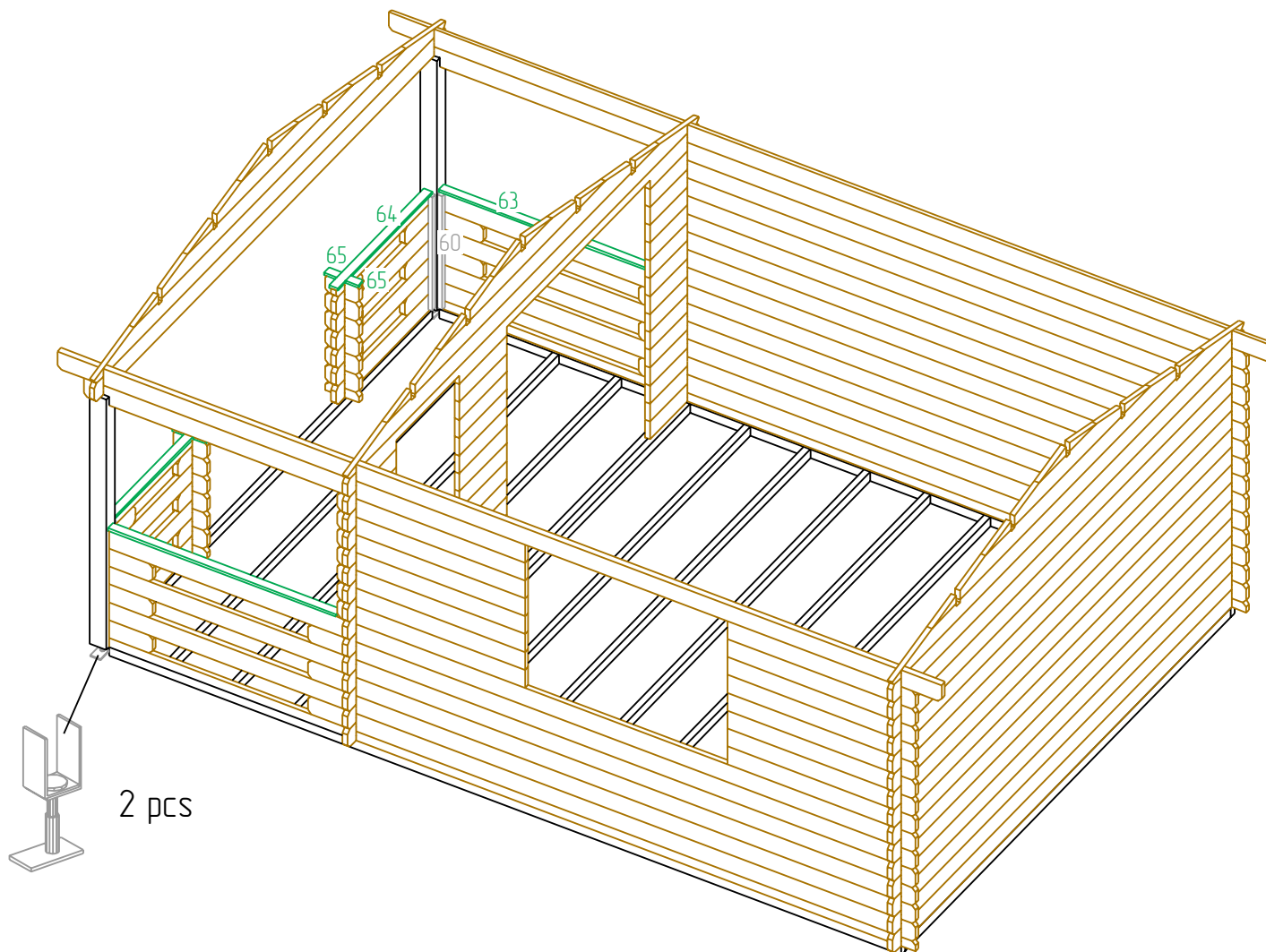



STAGE 3

Shanon 34 4X6

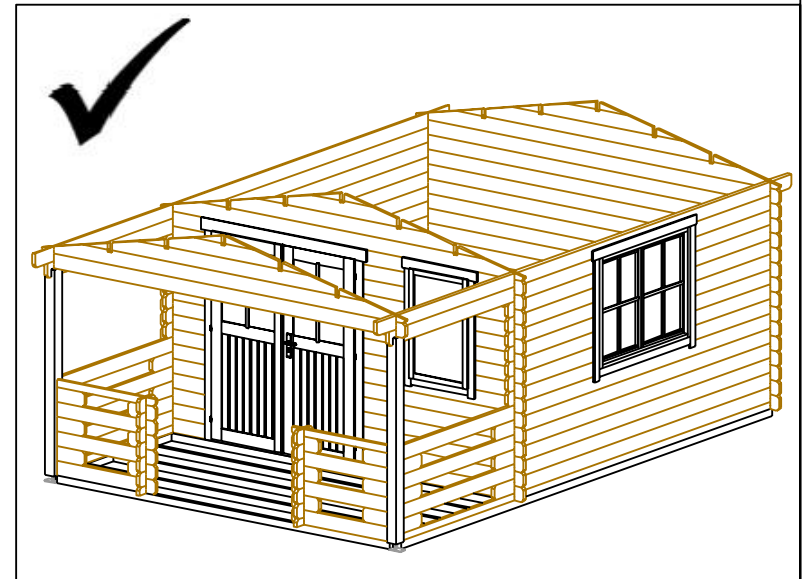
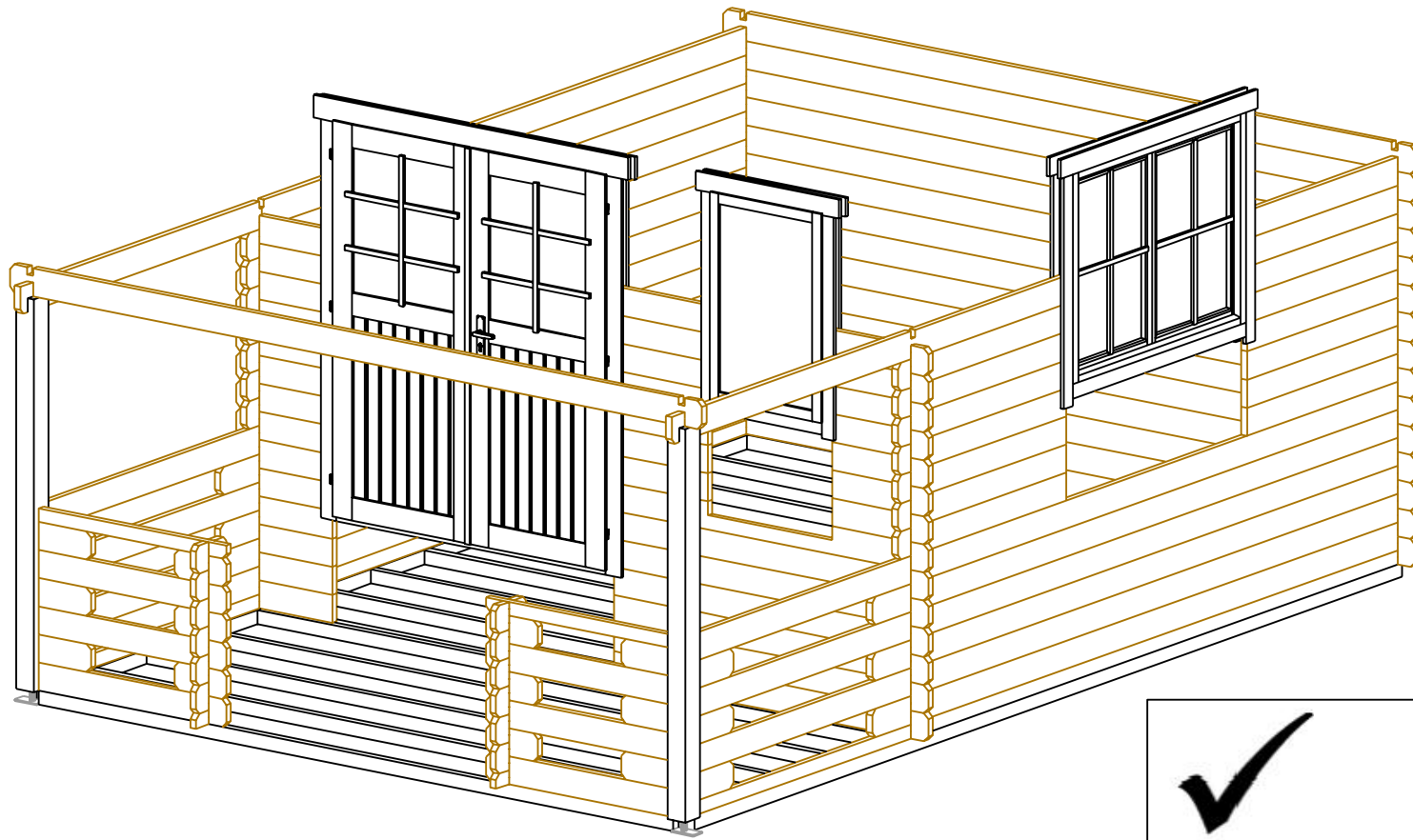

STAGE 4

Shanon 34 4X6

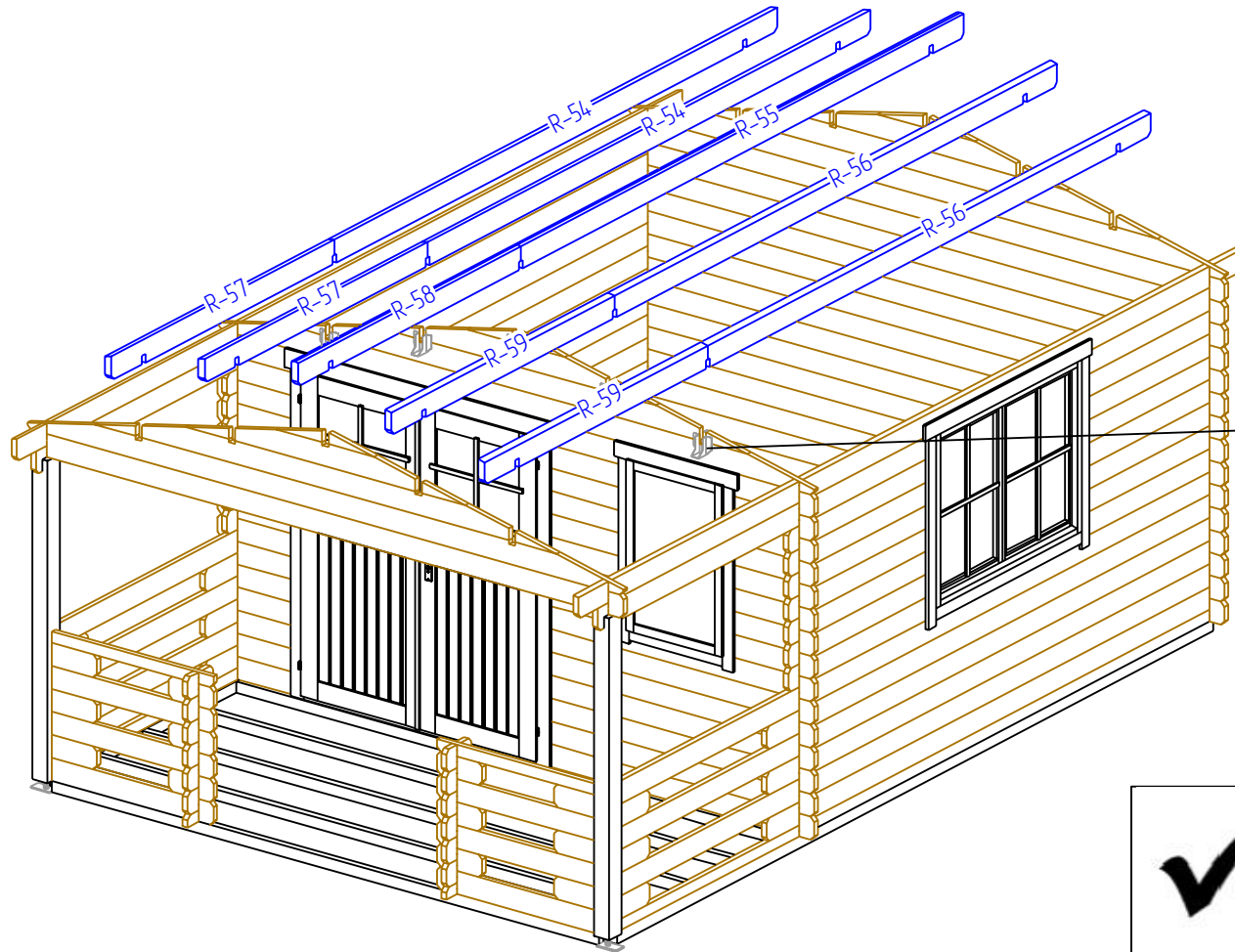

10 pcs

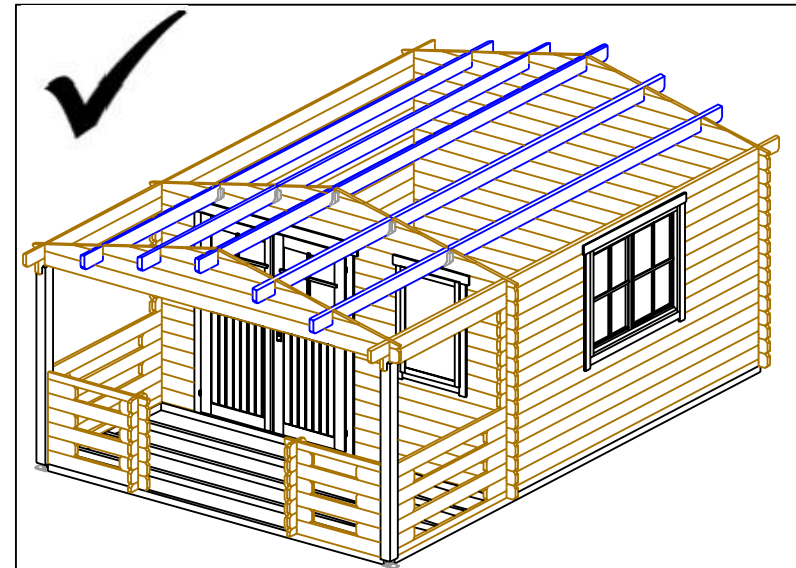

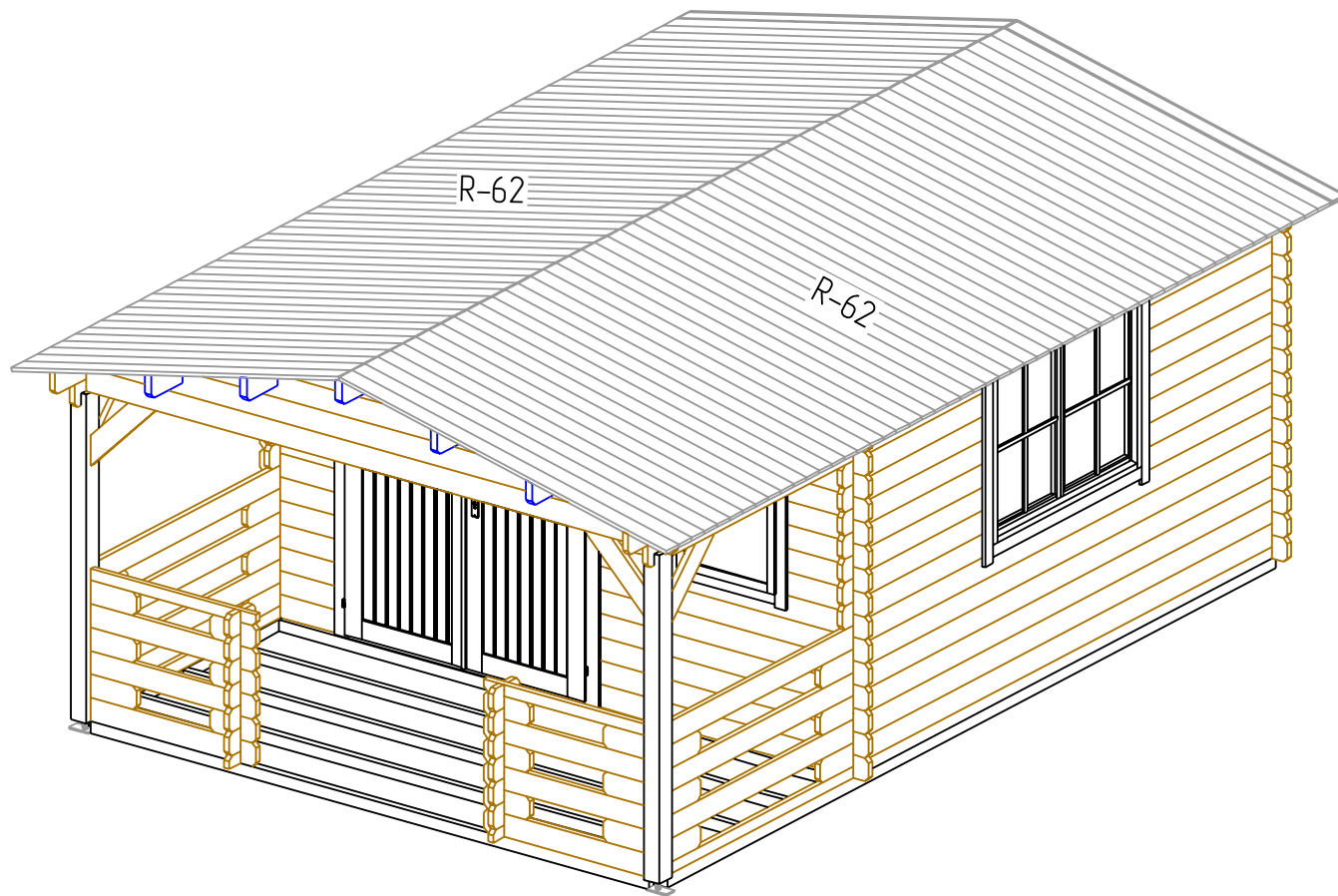

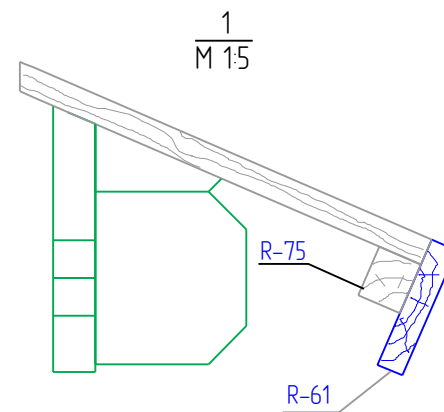
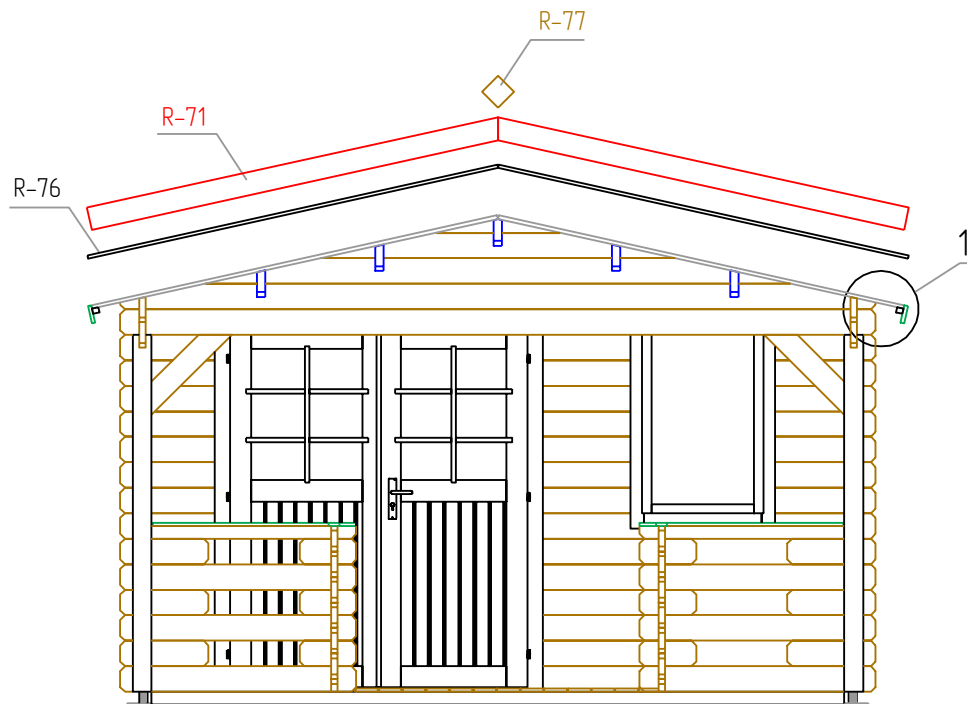

STAGE 6

Shanon 34 4X6

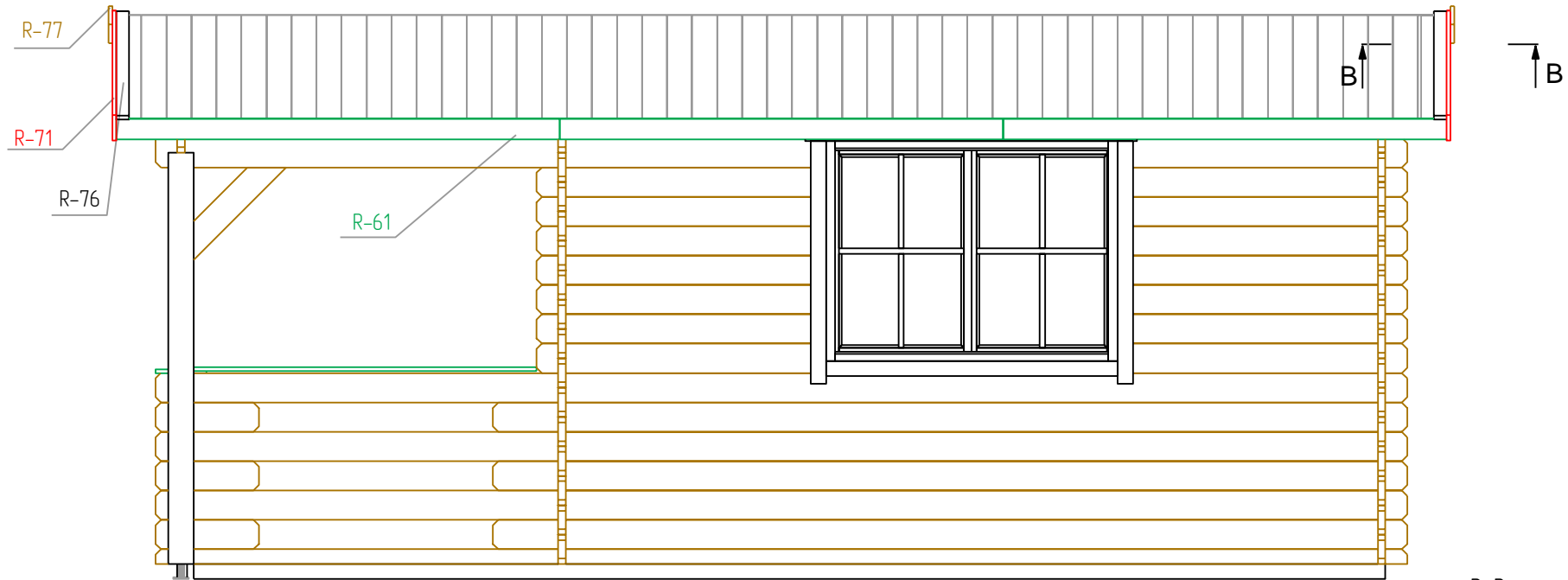

B-B  
M 15

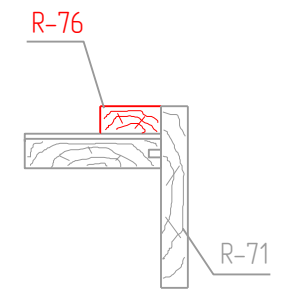

STAGE 7

Shanon 34 4X6

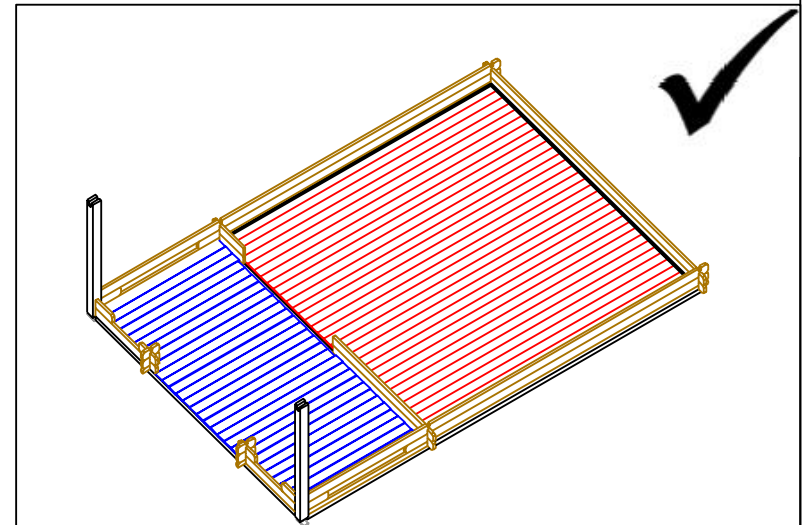
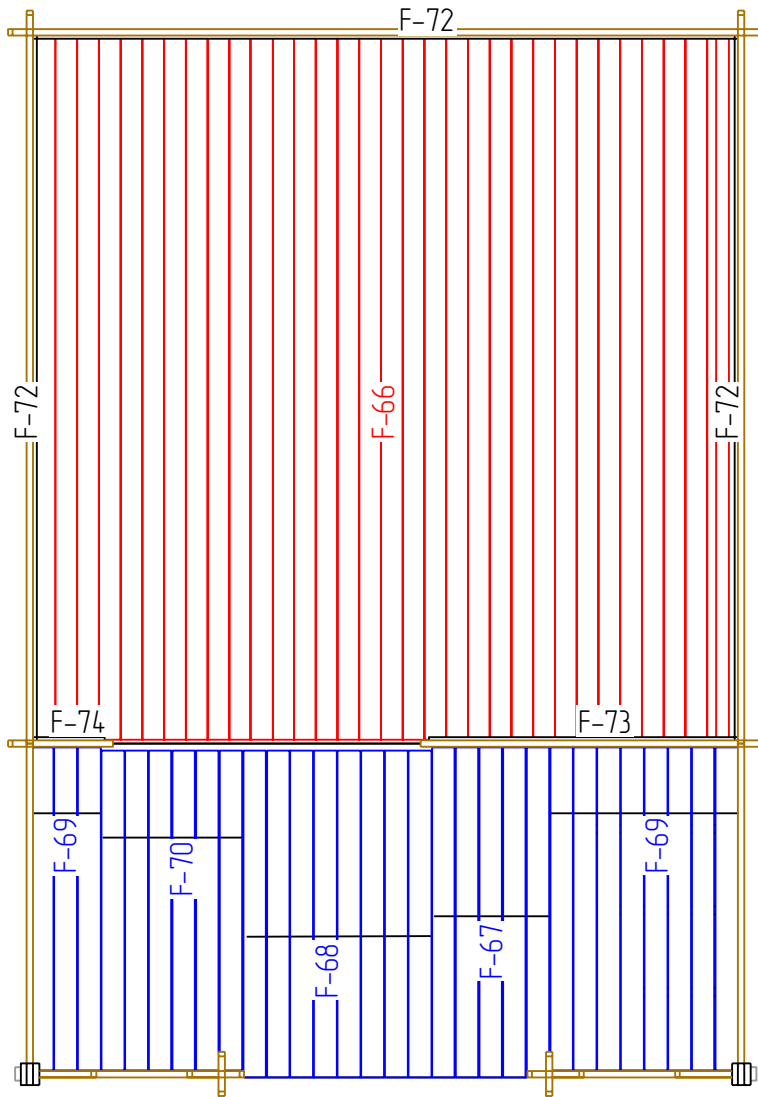

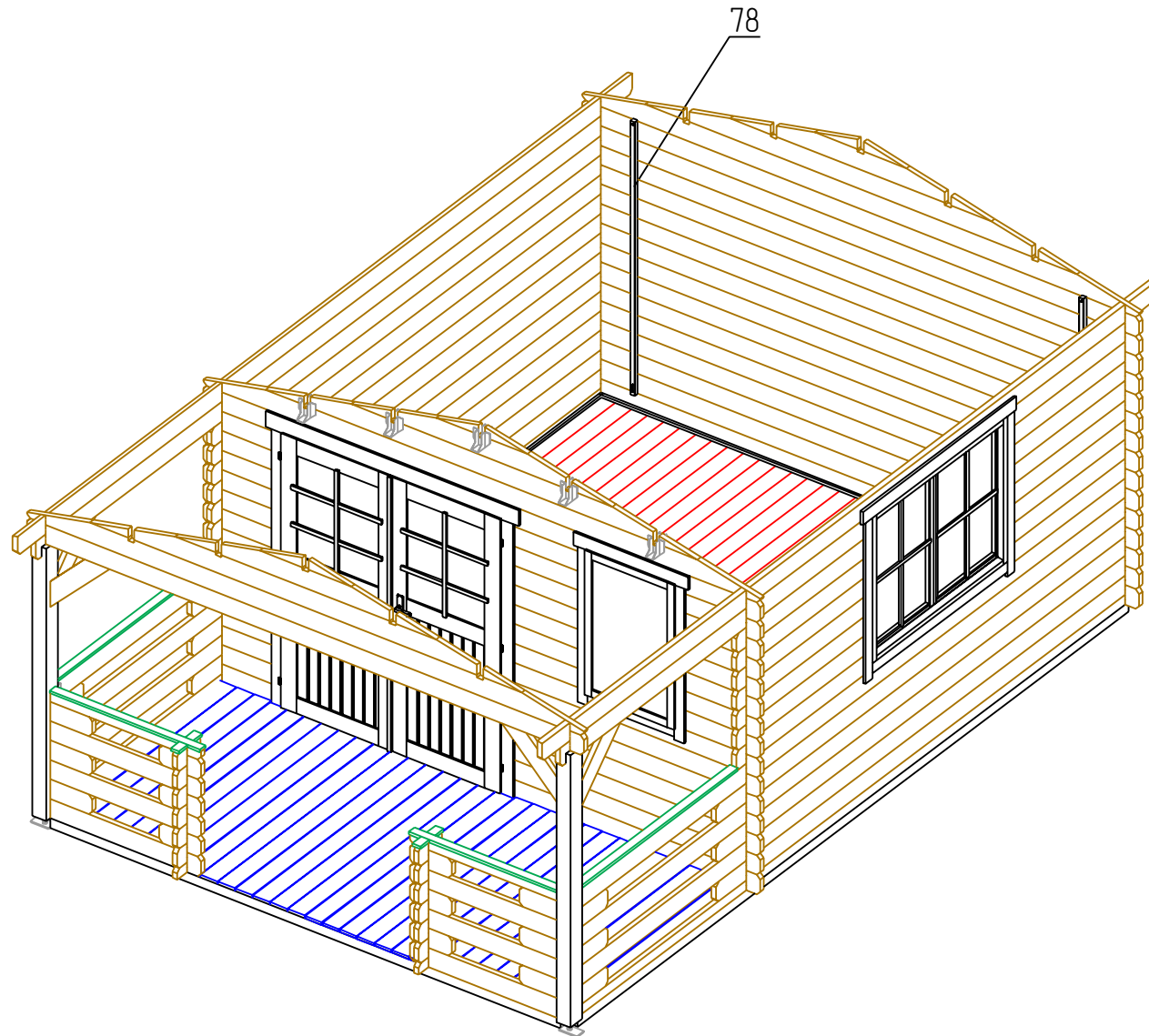

STAGE 1

F  
NR: 47  
PSC: 2  
B/H: 44mm/68mm  
L: 5475mm

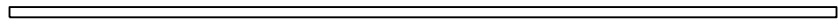

F  
NR: 48  
PSC: 14  
B/H: 44mm/68mm  
L: 3712mm

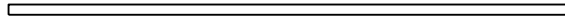

F  
NR: 49  
PSC: 1  
B/H: 44mm/68mm  
L: 3666mm

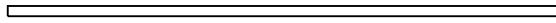

NR: 50  
PSC: 2  
B/H: 100mm/116mm  
L: 1890mm

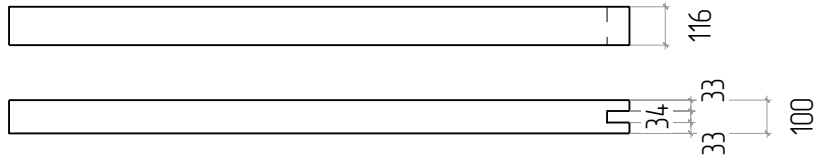

STAGE 2

W  
NR: A 1  
PSC: 1  
B/H: 34mm/68mm  
L: 3883mm



W  
NR: A 2  
PSC: 1  
B/H: 34mm/68mm  
L: 1692mm



W  
NR: A 3  
PSC: 1  
B/H: 34mm/133mm  
L: 4063mm



W  
NR: A 4  
PSC: 1  
B/H: 34mm/133mm  
L: 2047mm

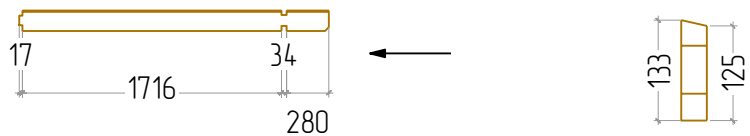

W  
NR: A 5  
PSC: 3  
B/H: 34mm/135mm  
L: 4200mm



W  
NR: A 6  
PSC: 7  
B/H: 34mm/135mm  
L: 4000mm











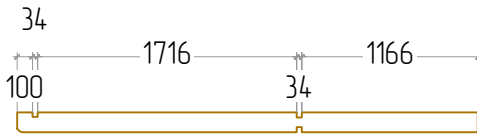

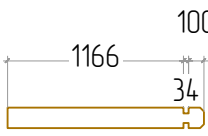

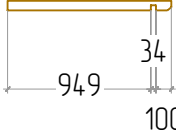
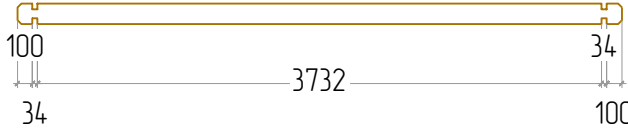
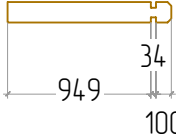
# Shanon 34 4X6

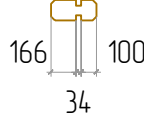
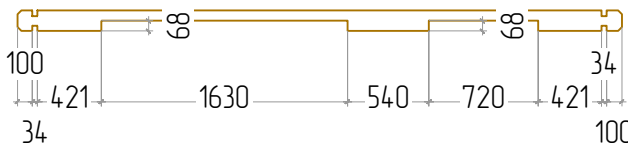
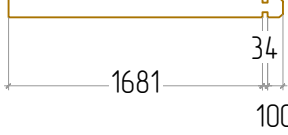
<p>W NR: A 7 PSC: 5 B/H: 34mm/135mm L: 3883mm</p>	
<p>W NR: A 8 PSC: 1 B/H: 34mm/135mm L: 1867mm</p>	
<p>W NR: A 9 PSC: 4 B/H: 34mm/135mm L: 1692mm</p>	
<p>W NR: A 10 PSC: 3 B/H: 34mm/135mm L: 300mm</p>	
<p>W NR: B 12 PSC: 15 B/H: 34mm/135mm L: 4000mm</p>	
<p>W NR: C 16 PSC: 1 B/H: 34mm/68mm L: 3883mm</p>	
<p>W NR: C 17 PSC: 1 B/H: 34mm/68mm L: 1692mm</p>	
<p>W NR: C 18 PSC: 1 B/H: 34mm/133mm L: 4063mm</p>	
<p>W NR: C 19 PSC: 1 B/H: 34mm/133mm L: 2047mm</p>	
<p>W NR: C 20 PSC: 3 B/H: 34mm/135mm L: 4200mm</p>	
<p>W NR: C 21 PSC: 3 B/H: 34mm/135mm L: 3883mm</p>	



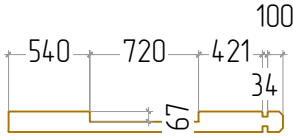
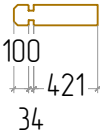

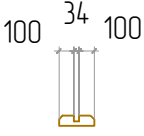
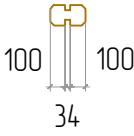
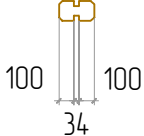
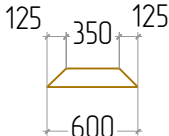
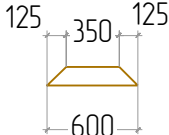
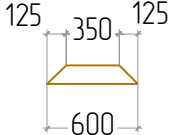
# Shanon 34 4X6

<p>W NR: C 22 PSC: 1 B/H: 34mm/135mm L: 3050mm</p>	
<p>W NR: C 23 PSC: 3 B/H: 34mm/135mm L: 1692mm</p>	
<p>W NR: C 24 PSC: 15 B/H: 34mm/135mm L: 1300mm</p>	
<p>W NR: C 25 PSC: 3 B/H: 34mm/135mm L: 300mm</p>	
<p>W NR: D 26 PSC: 2 B/H: 34mm/67mm L: 1083mm</p>	
<p>W NR: D 28 PSC: 1 B/H: 34mm/135mm L: 4000mm</p>	
<p>W NR: D 32 PSC: 6 B/H: 34mm/135mm L: 1083mm</p>	
<p>W NR: D 33 PSC: 6 B/H: 34mm/135mm L: 300mm</p>	
<p>W NR: D 34 PSC: 6 B/H: 34mm/135mm L: 300mm</p>	
<p>W NR: E 36 PSC: 1 B/H: 34mm/135mm L: 4000mm</p>	
<p>W NR: E 40 PSC: 6 B/H: 34mm/135mm L: 1815mm</p>	







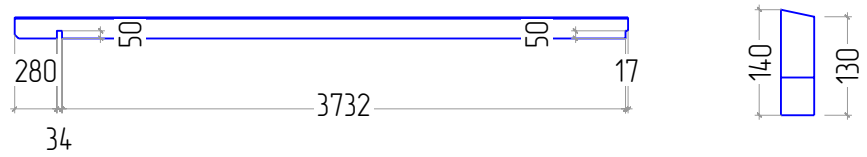
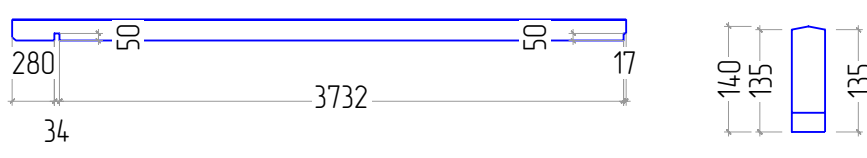
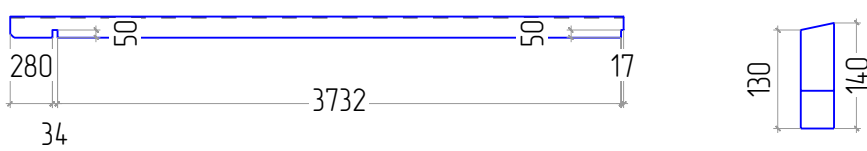

# Shanon 34 4X6

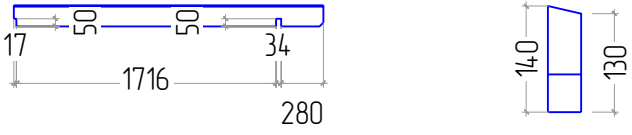
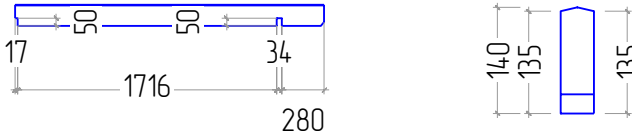
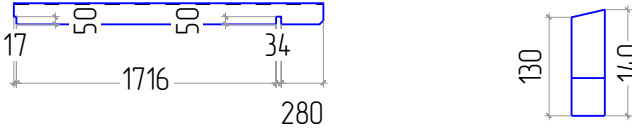
<p>W NR: E 41 PSC: 1 B/H: 34mm/135mm L: 1815mm</p>	
<p>W NR: E 42 PSC: 21 B/H: 34mm/135mm L: 555mm</p>	
<p>W NR: E 43 PSC: 7 B/H: 34mm/135mm L: 540mm</p>	
<p>W NR: F 44 PSC: 2 B/H: 34mm/68mm L: 234mm</p>	
<p>W NR: F 45 PSC: 2 B/H: 34mm/134mm L: 234mm</p>	
<p>W NR: F 46 PSC: 10 B/H: 34mm/135mm L: 234mm</p>	
<p>W NR: A 51 PSC: 1 B/H: 34mm/125mm L: 600mm</p>	
<p>W NR: C 52 PSC: 1 B/H: 34mm/125mm L: 600mm</p>	
<p>W NR: D 53 PSC: 2 B/H: 34mm/125mm L: 600mm</p>	
<p>W NR: B PSC: 1</p>	
<p>W NR: D PSC: 1</p>	

# Shanon 34 4X6

W NR: E PSC: 1	
NR: 60 PSC: 4 B/H: 28mm/34mm L: 859mm	
NR: 63 PSC: 2 B/H: 18mm/58mm L: 1575mm	
NR: 64 PSC: 2 B/H: 18mm/58mm L: 1079mm	
NR: 65 PSC: 4 B/H: 18mm/58mm L: 88mm	
<h2 style="margin: 0;">STAGE 3</h2>	
Door PSC: 1 B/H: 1630mm/1958mm	
Window PSC: 1 B/H: 1400mm/1080mm	
Window PSC: 1 B/H: 720mm/1080mm	
<h2 style="margin: 0;">STAGE 4</h2>	
R NR: 54 PSC: 2 B/H: 44mm/140mm L: 4063mm	
R NR: 55 PSC: 1 B/H: 44mm/140mm L: 4063mm	
R NR: 56 PSC: 2 B/H: 44mm/140mm L: 4063mm	

# Shanon 34 4X6

R NR: 57 PSC: 2 B/H: 44mm/140mm L: 2047mm	
R NR: 58 PSC: 1 B/H: 44mm/140mm L: 2047mm	
R NR: 59 PSC: 2 B/H: 44mm/140mm L: 2047mm	
<b>STAGE 5</b>	
R NR: 62 PSC: 109 B/H: 20mm/115mm L: 2200mm	
<b>STAGE 6</b>	
R NR: 61 PSC: 6 B/H: 18mm/95mm L: 2037mm	
R NR: 71 PSC: 4 B/H: 18mm/120mm L: 2228mm	
R NR: 75 PSC: 6 B/H: 28mm/34mm L: 2037mm	
R NR: 76 PSC: 4 B/H: 18mm/58mm L: 2223mm	
R NR: 77 PSC: 2 B/H: 18mm/120mm L: 120mm	
<b>STAGE 7</b>	
F NR: 66 PSC: 34 B/H: 20mm/115mm L: 3728mm	

<p>F NR: 72 PSC: 3 B/H: 18mm/20mm L: 3732mm</p>	<p><input type="checkbox"/></p>
<p>F NR: 73 PSC: 1 B/H: 18mm/20mm L: 1638mm</p>	<p><input type="checkbox"/></p>
<p>F NR: 74 PSC: 1 B/H: 18mm/20mm L: 378mm</p>	<p><input type="checkbox"/></p>
<p>F NR: 67 PSC: 6 B/H: 120mm/18mm L: 1748mm</p>	<p><input type="checkbox"/></p>
<p>F NR: 68 PSC: 8 B/H: 120mm/18mm L: 1730mm</p>	<p><input type="checkbox"/></p>
<p>F NR: 69 PSC: 11 B/H: 120mm/18mm L: 1712mm</p>	<p><input type="checkbox"/></p>
<p>F NR: 70 PSC: 6 B/H: 120mm/18mm L: 1694mm</p>	<p><input type="checkbox"/></p>
<p>STAGE 8</p>	
<p>NR: 78 PSC: 4 B/H: 28mm/34mm L: 1900mm</p>	<p><input type="checkbox"/></p>